

Operating temperature: max. 90 °C
Operating pressure: max. 10 bar

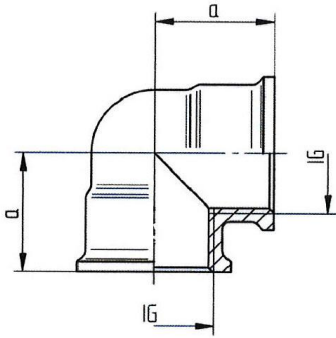

253.54

90° elbow, female/female

Art. No.	Type No.	Thread	a mm
112625	253.51	G 1/8	17.5
Discontinued product			
112626	253.52	G 1/4	17.5
112626 = discontinued product. No longer available. New product 194100 (WST14MS90II)			
112627	253.53	G 3/8	20.0
112628	253.54	G 1/2	25.0
112629	253.55	G 3/4	30.0
112630	253.56	G 1	33.0
112630 = discontinued product. No longer available. New product 194104 (WST10MS90II)			
112631	253.57	G 1 1/4	45.0
112631 = discontinued product. No longer available. New product 194105 (WST114MS90II)			
112632	253.58	G 1 1/2	48.0
112633	253.59	G 2	60.0
112633 = discontinued product. No longer available. New product 194107 (WST20MS90II)			

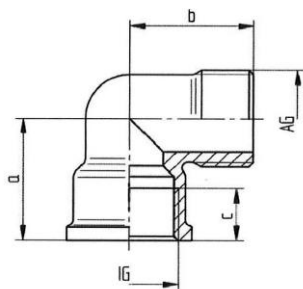

253.64

90° elbow, female/male

Art. No.	Type No.	Thread	a mm	b mm	c mm
112634	253.62	G 1/4	17.5	28.0	10.0
112635	253.63	G 3/8	28.0	28.0	12.0
112636	253.64	G 1/2	35.0	35.0	15.0
112637	253.65	G 3/4	38.0	38.0	16.0
112638	253.66	G 1	42.0	42.0	18.0
112638 = discontinued product. No longer available. New product 194112 (WST10MS90IA)					
112639	253.67	G 1 1/4	55.0	55.0	21.4
112640	253.68	G 1 1/2	60.0	60.0	21.4
112640 = discontinued product. No longer available. New product 194114 (WST112MS90IA)					
112641	253.69	G 2	69,0	69,0	26,0
112641 = discontinued product. No longer available. New product 194115 (WST20MS90IA)					

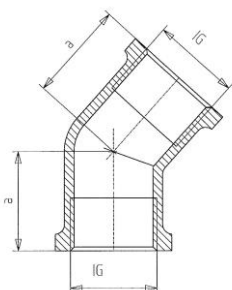

253.74



253.74-1

45° elbow, female/female

Art. No.	Type No.	Thread	a mm
112642	253.73	G 3/8 x G 3/8	21.5
Discontinued product			
156141	253.73-1	G 3/8 x G 3/8	17,5
Discontinued product			
112643	253.74	G 1/2 x G 1/2	25.0
112643 = discontinued product. No longer available. New product 156151 (253.74-1)			
156151	253.74-1	G 1/2 x G 1/2	19,5
Discontinued product			
112644	253.75	G 3/4 x G 3/4	30.0
112645	253.76	G 1 x G 1	33.0

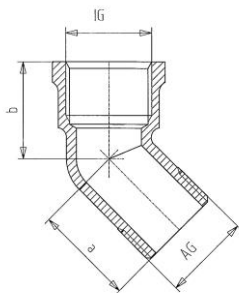

253.84



253.85-1

45° elbow, female/male

Art. No.	Type No.	Thread	a mm	b mm
112646	253.83	G 3/8 x G 3/8	16.0	18.5
Discontinued product				
156142	253.83-1	G 3/8 x G 3/8	23,0	20,0
Discontinued product				
112647	253.84	G 1/2 x G 1/2	30.5	22.5
112648	253.85	G 3/4 x G 3/4	30.5	29.5
Discontinued product				
156152	253.85-1	G 3/4 x G 3/4	30,0	28,5
Discontinued product				
112649	253.86	G 1 x G 1	37.0	29.0

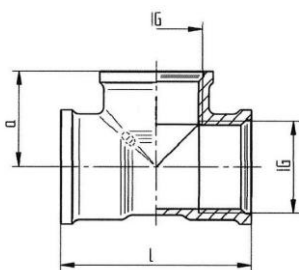

256.14

Tee, 3 x female thread

Art. No.	Type No.	Thread	l mm	a mm
112650	256.11	G 1/8	35.0	17.5
Discontinued product				
112651	256.12	G 1/4	35.0	17.5
112652	256.13	G 3/8	43.0	21.5
112653	256.14	G 1/2	50.0	25.0
112654	256.15	G 3/4	60.0	30.0
112655	256.16	G 1	66.0	33.0
112655 = discontinued product. No longer available. New product 194126 (TST10MSIG)				
112656	256.17	G 1 1/4	90.0	45.0
112657	256.18	G 1 1/2	96.0	48.0
112658	256.19	G 2	120.0	60.0

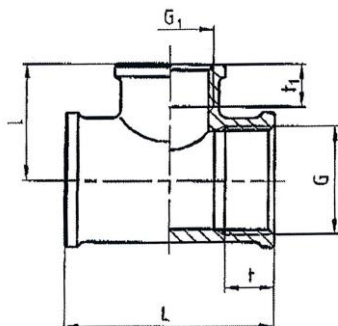

253.95

Unequal tee, 3 x female thread

Art. No.	Type No.	Thread G	Thread G ₁	t mm	t ₁ mm	l mm	L mm
112659	253.94	G 1/2	G 3/8	12.5	10.0	26.0	51.0
112660	253.95	G 3/4	G 1/2	16.0	14.0	27.0	60.0
112661	253.96	G 1	G 1/2	19.0	15.0	32.0	67.0
112661 = discontinued product. No longer available. New product 194131 (TRED101210MSIG)							
112662	253.97	G 1	G 3/4	15.5	15.0	34.0	67.0
112662 = discontinued product. No longer available. New product 194132 (TRED103410MSIG)							

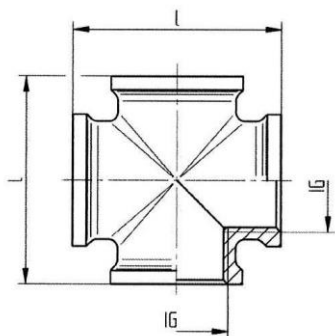

256.24

Cross, 4 x female thread

Art. No.	Type No.	Thread IG	l mm
112663	256.23	3/8	43.0
112664	256.24	1/2	50.0
112665	256.25	3/4	60.0
112665 = discontinued product. No longer available. New product 194134 (KST34MSIG)			